

CATALOG 2021

Complete line of pool drains & fittings



GO
BEYOND
ORDINARY



Color Match
POOL FITTINGS, INC.

LETTER FROM THE PRESIDENT

COLOR MATCH POOL FITTINGS

Color Match Pool Fittings began with the idea of creating products that would blend with any pool finish and not detract from beautiful pool designs. We launched our first Pebble Top Drain Cover in 1999, making the only disappearing drain that blended both beauty & function.

Today our innovative products include a complete Pebble Top Portfolio of drain covers, floor returns, pole holders, and pop-up cleaning heads that blend in using any plaster, aggregate, or tile finish. We've also applied this same technology to the vinyl market with the only disappearing Vinyl Top Drain Cover.

We take great pride in being a leader in innovative pool products that your customers will love and that will set you apart from your competition.

We look forward to partnering with you as we go beyond ordinary and take your pool designs to the next level.

Todd Krombein
President

Cover Photo: Crystal Clear Pools & Spas

CONTENT

WHAT IS PEBBLE TOP TECHNOLOGY	4
.....	
ABOUT OUR PRODUCTS	6
.....	
360 PEBBLE TOP DRAIN - 20" UNBLOCKABLE	12
.....	
CHANNEL PEBBLE TOP DRAIN COVER	17
.....	
PEBBLE TOP DRAIN COVERS - 8" & 10"	19
.....	
PEBBLE TOP FLOOR RETURN	22
.....	
PEBBLE TOP POLE HOLDERS	25
.....	
PEBBLE TOP CLEANING HEADS	26
.....	
VINYL TOP DRAIN COVERS	28
.....	
VINYL SKIMMER BEAUTY KIT & RING	32
.....	
STANDARD ANTI-VORTEX DRAIN COVERS	35
.....	
STANDARD RETROFIT UNIVERSAL DRAIN COVERS	37
.....	
DESIGNER FITTINGS	39
.....	
HOW TO ORDER	47



WHAT IS **PEBBLE TOP TECHNOLOGY**

Our patented Pebble Top Products have unique fillable lids that adhere the same plaster, aggregate, or tile being applied in the pool, directly to the top of the drain cover or fitting.

By matching the exact finish, they virtually disappear into your pool or spa.

Photo: Design Pool & Spa

PEBBLE TOP PORTFOLIO

MAKE UGLY DRAINS & FITTINGS DISAPPEAR



20-inch VGB Unblockable

360 PEBBLE TOP DRAINS

- Unblockable - Only one drain needed
- Fill lid with any plaster, aggregate, or tile to match pool finish
- Flush with floor, no pool cleaner hang ups
- Outstanding flow rate of 310 GPM

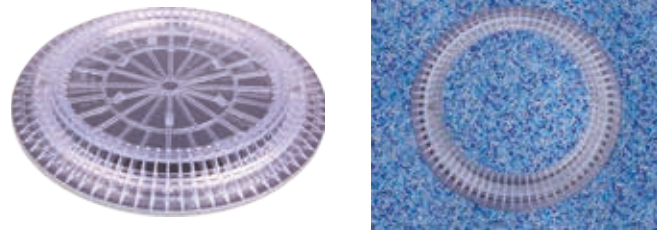

Patented

8-inch, 10-inch, & Channel

PEBBLE TOP DRAIN COVERS

- Fill lid with any plaster, aggregate, or tile to match pool finish
- VGB, ANSI/APSP 16-2001 and NSF/ANSI 50-2015 Certified
- Flow Rates up to 208 GPM



Patent Pending

ETROFIT PEBBLE TOP COVERS

- 10-inch Retrofit Drain Cover has built-in adaptor plate that can attach to any standard sump 10-inch or smaller
- Fill lid with any plaster, aggregate, or tile to match pool finish
- VGB, ANSI/APSP 16-2001 and NSF/ANSI 50-2015 Certified



Patented

CHANNEL PEBBLE TOP COVERS

- Fits with A&A AVSC Channel Drain
- Unblockable - only one drain needed
- Fill lid with any plaster, aggregate, or tile to match pool finish
- VGB, ANSI/APSP 16-2001 and NSF/ANSI 50-2015 Certified

PEBBLE TOP FLOOR RETURNS

Pebble Top Adjustable Lid can be filled with any matching plaster, aggregate, or tile



Patent Pending



Patent Pending

PEBBLE TOP POLE HOLDER

Fill Cap with any matching plaster, aggregate, or tile



Patent Pending

PEBBLE TOP GAMMA 3 HEAD

Rotating Nozzle Fits A&A Gamma 3 or Gamma 4 In-Floor Cleaning System

DISCOVER THE PEBBLE TOP DIFFERENCE



UGLY DRAINS & FITTINGS
STAND OUT AND DETRACT
FROM YOUR BEAUTIFUL
POOL DESIGN

PEBBLE TOP PRODUCTS
DISAPPEAR WITH MATCHING FINISH

- PEBBLE TOP DRAIN COVERS
- PEBBLE TOP FLOOR RETURNS
- PEBBLE TOP POLE HOLDERS
- PEBBLE TOP POP-UP CLEANING HEADS



Photo: Poolscape Unlimited

PEBBLE TOP TECHNOLOGY

“ Making your drains and fittings disappear into your pool or spa

Our patented Pebble Top products have fillable lids to match any finish making the drains and fittings disappear into your pool or spa. This unique feature adheres the same plaster, aggregate, or tile being applied to your pool, directly to the top of the drain cover or fitting for a perfect match.

Stop using plain drains that stand out and detract from the look of your beautiful pool design. Take your designs to the next level by using our complete line of pebble top products, including drain covers, floor returns, pole holders, and pop-up cleaning heads. You and your customers will be amazed at the Pebble Top difference.

NOT JUST FOR PEBBLE FINISHES

Don't let the name fool you. You can apply any plaster, aggregate, or tile (as shown below) to our Pebble Top Drain Covers. With eight designer colors, including Clear, you're sure to find the perfect match for every pool finish.



Photo: Bennett Pool & Spa

INNOVATION

...FOR OVER 20 YEARS, COLOR MATCH POOL FITTINGS HAS LED THE WAY IN CREATING INNOVATIVE POOL DRAINS & FITTINGS THAT GO BEYOND ORDINARY

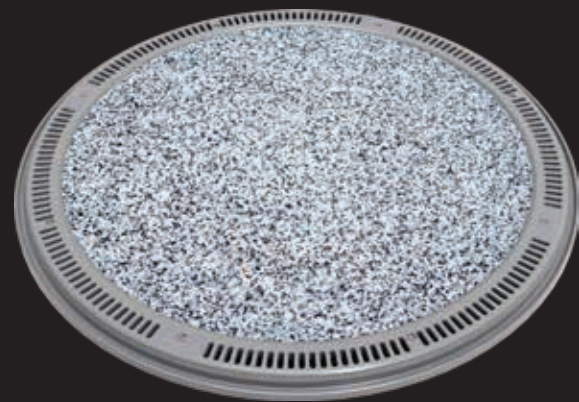

20" UNBLOCKABLE
360 PEBBLE TOP DRAIN

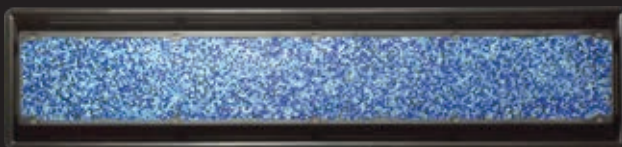

CHANNEL PEBBLE TOP
DRAIN COVER

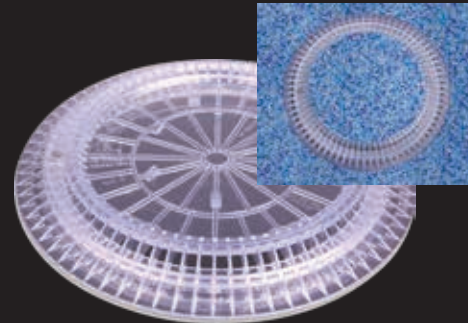

PEBBLE TOP
DRAIN COVERS

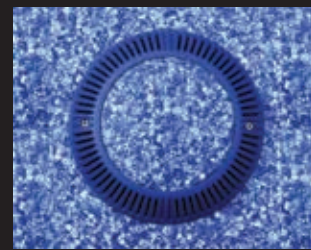

VINYL TOP
DRAIN COVERS



PEBBLE TOP
FLOOR RETURNS



SQUARE
FLUSH MOUNTS



PEBBLE TOP
POLE HOLDERS



PEBBLE TOP
POP UP HEADS

DISAPPEARS WITH MATCHING PLASTER, AGGREGATE, OR TILE

Clear Series

WE ARE THE ONLY COMPANY
TO OFFER A WIDE VARIETY OF POOL
DRAIN COVERS & FITTINGS IN CLEAR

Our Clear products will disappear like an ice cube in water.



8", 10", Channel
& New Retrofit
Pebble Top
Drain Covers

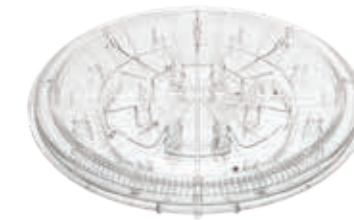

20" Unblockable
360 Pebble
Top Drains



Vinyl Top
Drain Covers



Pebble Top Floor Returns



Pole Holders



Fittings



Pebble Top Pop-Up Heads



Rope Anchors

20-INCH VGB UNBLOCKABLE 360 Pebble Top Drain

THE DISAPPEARING DRAIN: *Simply apply the same plaster, aggregate or tile being applied to the pool surface to the top of our 360 Pebble Top Drain for a perfect match every time.*



Patented
Flow Rate 310 GPM

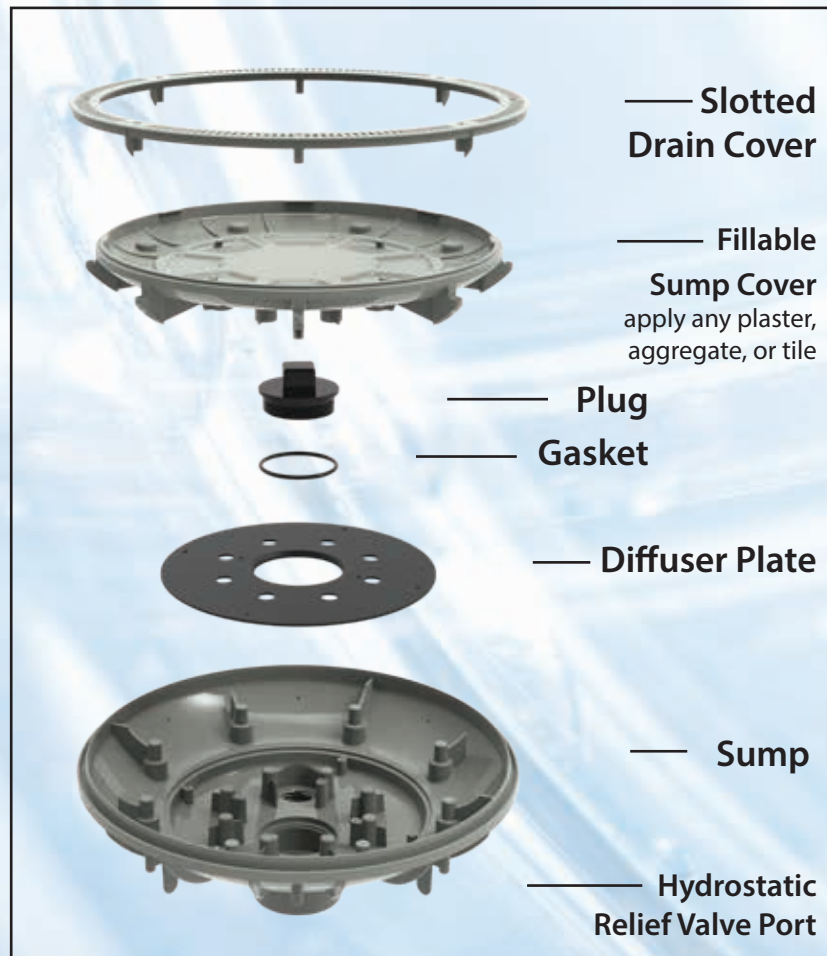

Color Options

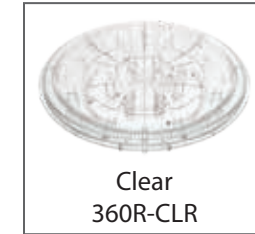

FEATURES

Our 20-inch Unblockable 360 Pebble Top Drain includes the sump. It's designed with our Pebble Top technology that adheres the same plaster, aggregate, or tile being applied to the pool, directly to the top of the drain to virtually disappear into your pool floor.

- 20" Round Unblockable Drain with sump
- Only one drain needed
- Excellent flow rate: 310 GPM
- Installs flush with pool floor, no pool cleaner hang ups
- Safety Engineered: VGB, ANSI/APSP-16 2011 and NSF/ANSI 50-2015 Compliant
- Built-In Hydrostatic Relief Valve Port
- Top is removable for easy access and clean out
- Area for the Slurry Pump to sit inside the sump
- Fits 2.5-inch, 3-inch, and 4-inch pipe
- Perfect for commercial and residential use



Photo:: Jimi Smith Photography for Marco Design Group

360 PEBBLE TOP DRAIN WITH PEBBLE TOP FLOOR RETURNS

*They finish flush with the spa floor
making them a winning combination.*



Photo: Crystal Clear Pools & Spas

VGB Unblockable Channel Pebble Top Drain Cover

Only One Drain Cover Needed

Patent #'s 6,209,586 / 6,340,035 / 6,557,588

FEATURES

This Unblockable Channel Pebble Top Drain Cover is designed with our Pebble Top Technology that adheres the same plaster, aggregate, or tile being applied to the pool, directly to the top of the drain cover to virtually disappear into your pool floor.

Channel Pebble Top Drain Cover

- Fits with A&A AVSC Channel Drain (sold separately)
- Safety Engineered: VGB, ANSI/APSP-16 2011 and NSF/ANSI 50-2015 Compliant
- Flow Rates: Single inlet 200 GPM; Dual inlet 208 GPM
- Manufactured from superior UV-Resistant ABS
- Available in 7 designer colors
- Proudly made in the USA

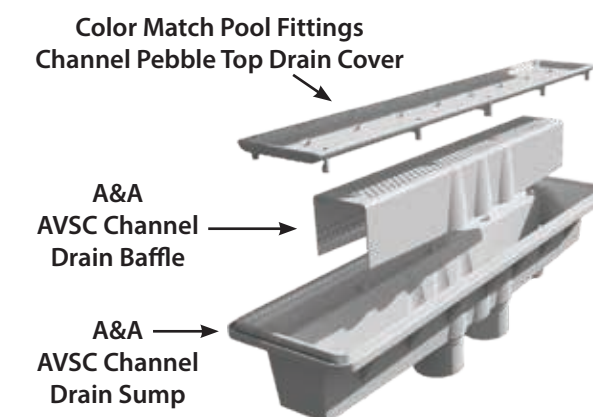

A&A AVSC Channel Drain (sold separately)

- Unblockable design
- Large Opening for debris removal
- Available in Single and Dual Inlet
- Save money: with dual inlet design you can use one AVSC Drain for two pumps
- Perfect for pools, spas, negative/vanishing edges, fountains, and water features
- Optional Hydrostatic Valve connection

Color Options

- White: AAM-CPTD-11
- Clear: AAM-CPTD-CLR
- Gold: AAM-CPTD-14
- Lt Gray: AAM-CPTD-13
- Gray: AAM-CPTD-15
- Black: AAM-CPTD-12
- Blue: AAM-CPTD-19

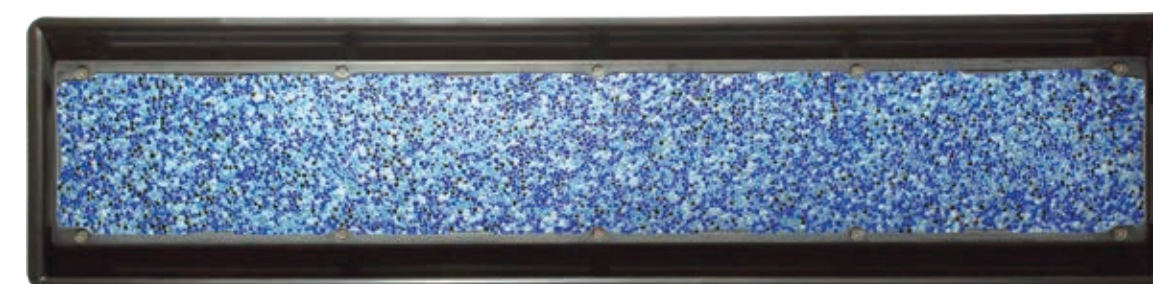

Photos: Questar Pools & Spas

NEW 10-inch VGB Retrofit Pebble Top Drain Cover

FEATURES

Perfect for new construction, renovations, or to replace existing pool/spa drain covers.

- Attaches to any 8" or 10" sump or mud ring
- Built-in universal adaptor plate with multiple screw holes
- Disappears by applying the same plaster, aggregate, or tile being applied in the pool/spa directly to the top of the drain cover
- Anti-Entrapment for safety: VGB, ANSI/APSP-16-2011 and NSF/ANSI 50-2015 Compliant
- Gradual slope for comfort and to reduce pool cleaner hang ups
- Flow Rates
2" Pipe: 156 GPM floor; 108 GPM wall
3" Pipe: 180 GPM floor; 112 GPM wall
- Proudly made in the USA
- Includes fillable drain cover, universal riser ring and screw pack



Fillable
Drain Cover

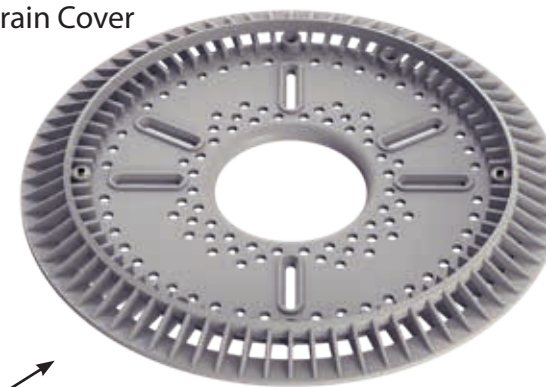

Universal Riser Ring
(with built-in adaptor plate)

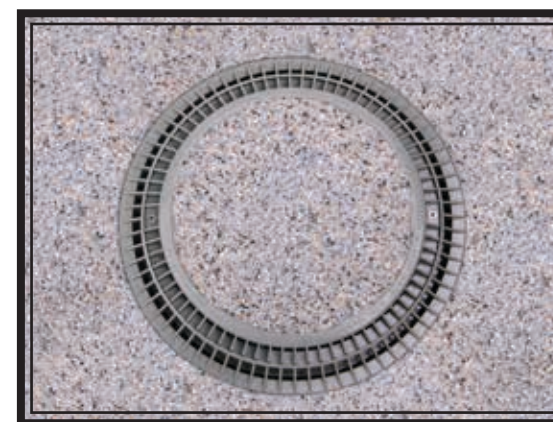

Patent Pending

*Attaches Directly
to Any Sump
or Mud Ring*

Color Options





Photo: Nassau Pools

8-inch VGB Pebble Top Drain Cover

Patent #'s 6,209,586 / 6,340,035 / 6,557,588

Color Options



FEATURES

Designed with Pebble Top Technology that adheres the same plaster, aggregate, or tile being applied to the pool, directly to the top of the drain cover to virtually disappear into your pool floor or wall.

- For single or multiple drain
- Safety Engineered: VGB, ANSI/APSP-16 2011 and NSF/ANSI 50-2015 Compliant
- Gradual slope for comfort and to reduce pool cleaner hang ups
- Flow Rates for 2-inch pipe: Floor 112 GPM, Wall 76 GPM
- Flow Rates for 3-inch pipe: Floor 144 GPM, Wall 100 GPM
- Manufactured from superior UV-Resistant ABS
- Available in 8 designer colors
- Proudly made in the USA
- Includes drain cover, riser ring, base ring, and Phillips screws

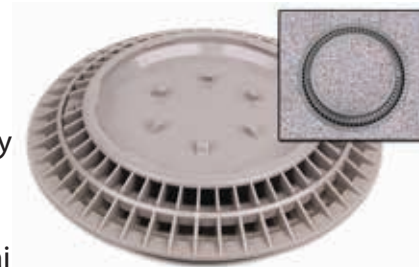

10-inch VGB Pebble Top Drain Cover

Patent #'s 6,209,586 / 6,340,035 / 6,557,588

Color Options



FEATURES

Designed with Pebble Top Technology that adheres the same plaster, aggregate, or tile being applied to the pool, directly to the top of the drain cover to virtually disappear into your pool floor or wall.

- For single or multiple drain
- Safety Engineered: VGB, ANSI/APSP-16 2011 and NSF/ANSI 50-2015 Compliant
- Gradual slope for comfort and to reduce pool cleaner hang ups
- Flow Rates for 2-inch pipe: Floor 156 GPM, Wall 148 GPM
- Flow Rates for 3-inch pipe: Floor 180 GPM, Wall 144 GPM
- Wide base ring that fits over most major brand sumps
- Manufactured from superior UV-Resistant ABS
- Available in 8 designer colors
- Proudly made in the USA
- Includes drain cover, riser ring, base ring, and Phillips screws

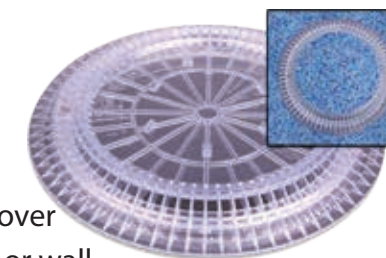



Patent Pending

Color Options



FEATURES

Simply apply the same finish being applied to the pool to the top of our Pebble Top Floor Return causing it to disappear into the pool floor. No More Ugly Fittings!

- Pebble Top Adjustable Lid can be filled with any finish
- Includes our patent pending Color Change Plate which allows you to easily convert the color to any of our eight color options
- Full 360-degrees of adjustable flow
- Built-in Water Stop to reduced leaks
- Fits 1.5-inch and 2-inch pipe
- Available in 8 designer colors, including Clear
- Engineered polymer UV-resistant ABS material
- Proudly made in the USA
- 25 Per Case

CAUTION: DO NOT use as a suction outlet



Photo: Vue Custom Pools

ADJUSTABLE

Pebble Top Floor Return

THE DISAPPEARING FLOOR RETURN: Simply apply the same plaster, aggregate or tile being applied to the pool to the top of our Pebble Top Floor Return for a perfect match every time.



Shown with filled lid. Pebble finish not included

Color Change Plate
Allows you to easily convert return to a different color after installation

Photo: Vue Custom Pools

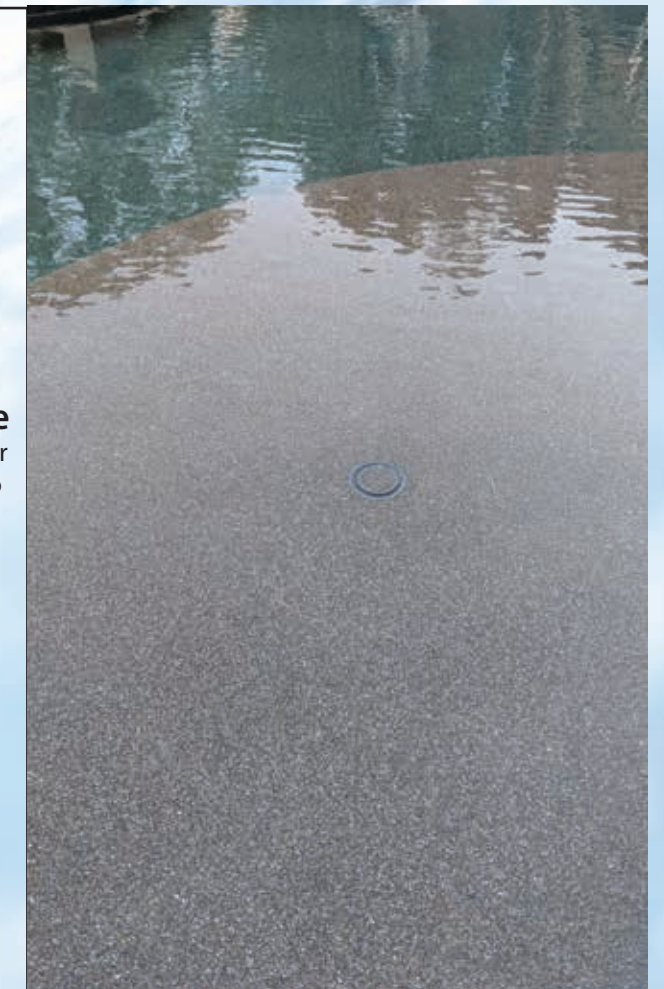

Retrofit Pebble Top Pole Holder Cap

Fits our standard 5-inch & 7-inch Pole Holders

Patent Pending

FEATURES

Simply apply the same finish being applied to the pool or deck to the top of our Retrofit Pebble Top Pole Holder Cap to blend in perfectly and disappear.

- Retrofit Pebble Top Pole Holder Cap replaces any standard pole holder cap
- Fillable Cap adheres same finish being applied to pool or deck to blend in perfectly
- Press-in cap closes off unit when not in use; can be removed for easy replacement
- Great for Umbrellas, Volleyball Poles and Tiki Torches
- Manufactured from UV-Resistant ABS Material
- Choose from 8 designer colors, including Clear
- Proudly made in the USA

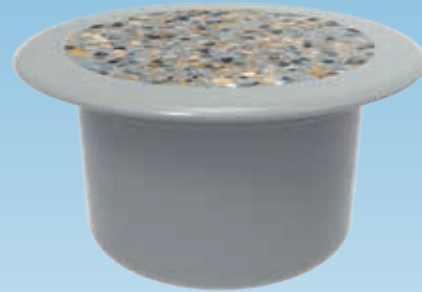

*Note: Does not come with pebble filled in as shown
Product comes empty so you can fill with matching finish*



Color Options



Pebble Top Pole Holder

With Fillable Cap

Patent Pending

FEATURES

Simply apply the same finish being applied to the pool or deck to the top of our Pebble Top Pole Holder Cap to blend in perfectly and disappear. No More Ugly Fittings!

- Fillable Cap designed to blend with pool or deck finish
- Designed to hold 1 ¼" or 1 ½" Pole
- Can be installed on pool floor, step, or surrounding pool deck
- Great for Umbrellas, Volleyball Poles and Tiki Torches
- Press-in cap closes off unit when not in use
- Cap can be removed for easy replacement
- Available in 7-inch size
- Manufactured from UV-Resistant ABS Material
- Choose from 8 designer colors, including Clear
- Proudly made in the USA
- Includes pole holder base & fillable cap
- Sold individually or 25 per case



*Note: Does not come with pebble filled in as shown
Product comes empty so you can fill with matching finish*

Pebble Top Fillable Cap

apply any plaster, aggregate, or tile

Pole Size Reducer/Stabilizer

Pole Holder Base

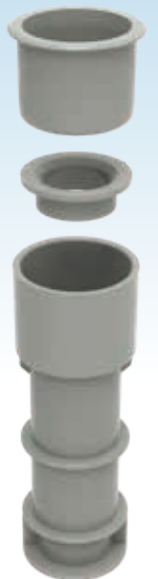

Color Options

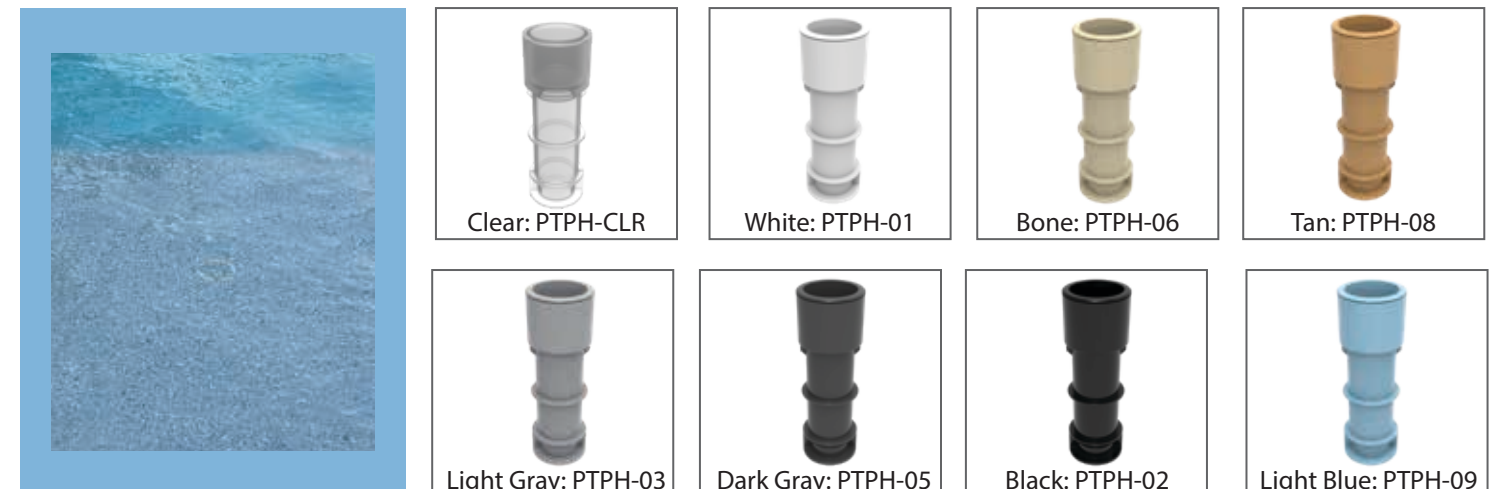

Pebble Top Gamma 3 Head

With Fillable Rotating Nozzle

Fits A&A's G3 or G4 In-Floor Cleaning System

Patent Pending

FEATURES

With our patented Pebble Top Technology, we've created the only true disappearing Pop Up Cleaning Head. Simply apply the same plaster, aggregate, or tile being applied to your pool surface to the top of the pop up cleaning heads for a perfect match every time. This new innovative design is perfect for new construction, remodeling, or to replace existing A&A G3 or G4 cleaning heads.

Fill with any plaster, aggregate, or tile. Shown here



Color Options



Standard Gamma 3 Cleaning Head

Fits A&A G3 or G4 In-floor Cleaning System

Patent Pending

FEATURES

Replacement part for A&A Gamma 3 or Gamma 4 High Flow Cleaning Heads. With a 7/16 in. orifice opening, this high flow nozzle is perfect for sweeping pool floors. Delivering powerful streams of filtered water, it also aids in the healthy circulation of your pool water and chemicals.



Color Options



PCC2000R Head

Standard Replacement Head

Fits Paramount PCC2000 In-floor Cleaning System



Color Options



VINYL DRAIN COVERS & FITTINGS



Introducing the first disappearing drain cover
made specifically for vinyl pools

Vinyl Top Drain Cover

Our patent pending design locks down the same vinyl liner being applied in the pool to the top of the drain cover for a perfect match.

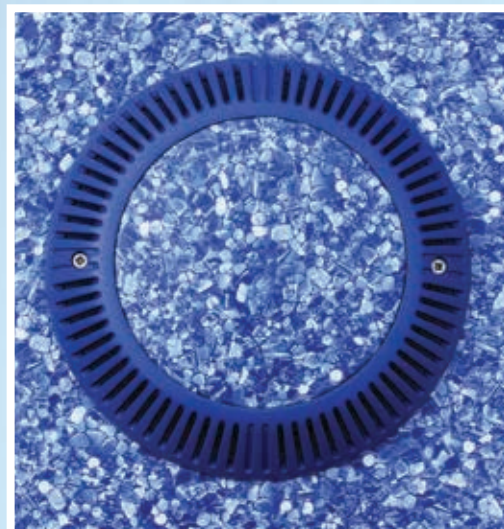

Patent Pending

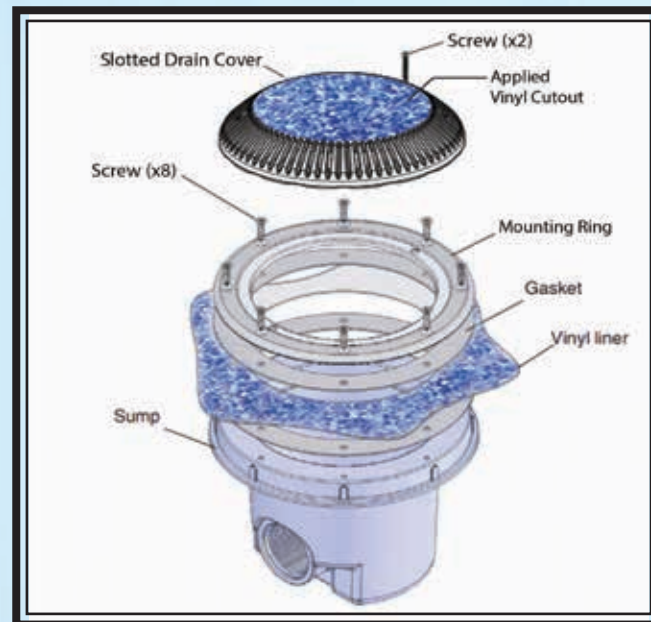

FEATURES

Designed specifically for use with vinyl pool liners to blend in perfectly and disappear into your pool floor. Simply adhere the same vinyl liner being applied to your pool in between the vinyl support plate and slotted drain cover for a perfect match.

- For single or multiple drain use
- Safety Engineered: VGB, ANSI/APSP-16 2011 and NSF/ANSI 50-2015 Compliant
- Fits standard vinyl liner sump
- Gradual slope for comfort and to reduce pool cleaner hang ups
- Flow Rates: Floor 130 GPM, Wall 72 GPM
- Manufactured from superior UV-Resistant ABS
- Available in 8 designer colors
- Proudly made in the USA
- Includes drain cover, support plate, mounting ring, gaskets, and Phillips screws

Color Options



*Vinyl Top Drain Cover
disappears in your pool floor*

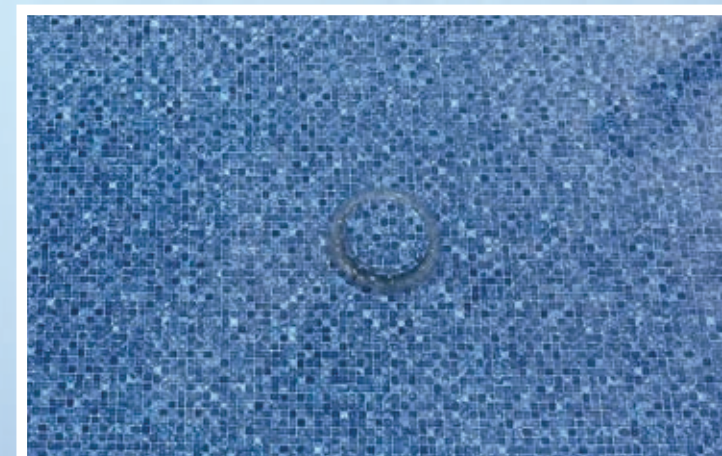
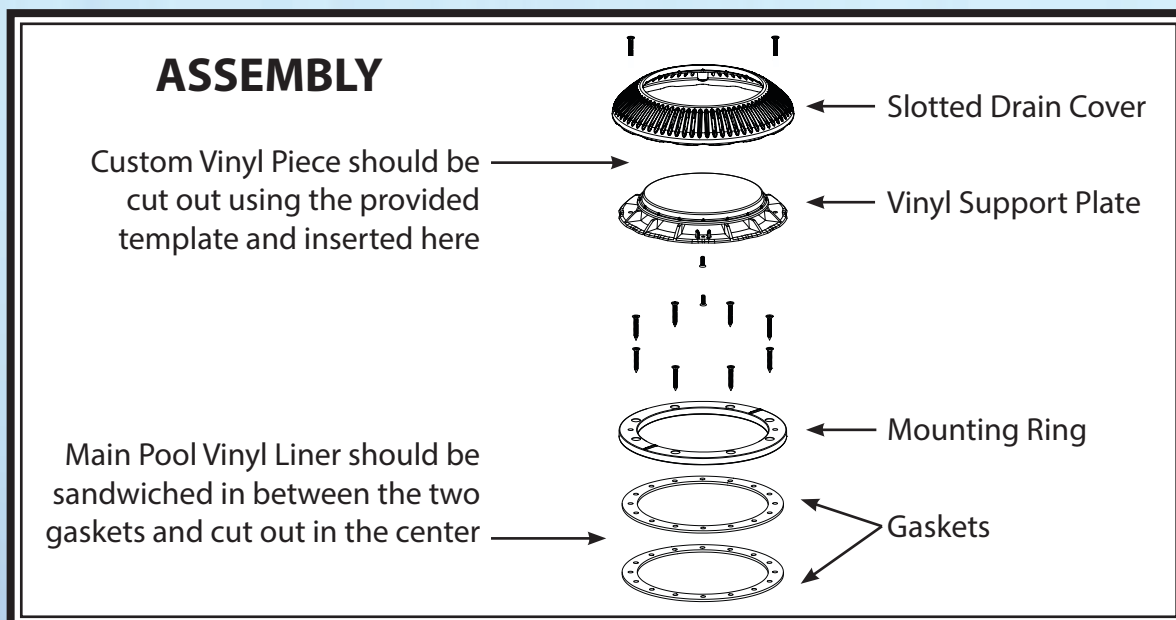

Photo: A Better Pool



Vinyl Beauty Ring

Patent Pending

Color Options

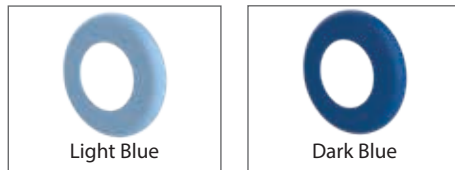
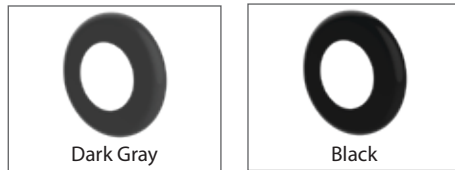
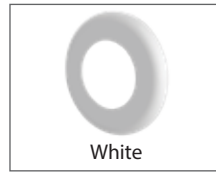

FEATURES

Make your fittings blend in to match your Vinyl Top Drain Cover and Skimmer

- Decorative Beauty Ring fits with our Threaded Eyeball Fitting shown below
- Manufactured from superior UV-Resistant ABS
- Proudly made in the USA

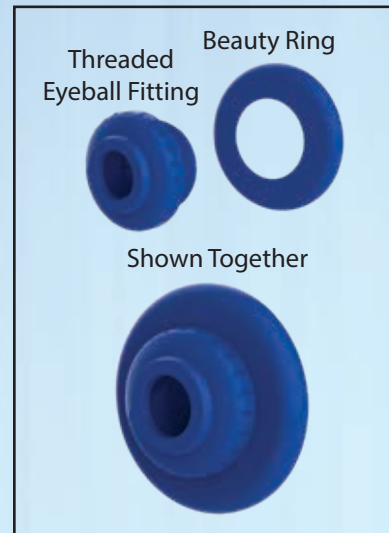

Vinyl Skimmer Beauty Kit

FEATURES

Make your skimmer blend in and match your disappearing Vinyl Top Drain Cover with our Skimmer Beauty Kit

- Includes decorative Faceplate, skimmer sleeve, and weir
- Simply attach each part, no glue needed
- Fits Hayward Skimmers SP1084 & SP1085
- Manufactured from superior UV-Resistant ABS
- Proudly made in the USA

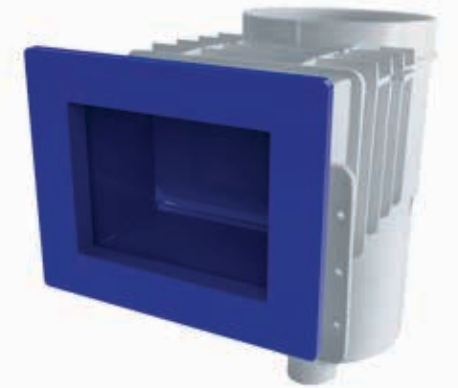

Fits Hayward Skimmers SP1084



Fits Hayward Skimmers SP1085

Skimmer Beauty Kit Parts

FACEPLATE

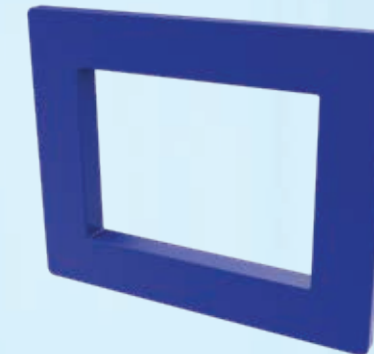

SKIMMER SLEEVE Patent Pending

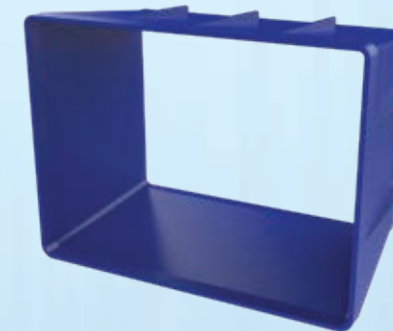

WEIR



Threaded Eyeball Fitting

FEATURES

Make your fittings blend in to match your Vinyl Top Drain Cover and Skimmer

- Fits any standard 1 1/2" female pipe thread
- Adjustable eyeball
- Manufactured from UV-Resistant ABS
- Proudly made in the USA

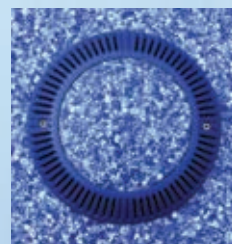

Now your skimmer and fittings can match your Vinyl Top Drain Cover

Color Options



Color Options





8-inch VGB Anti-Vortex Drain Cover

Color Options

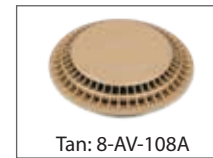
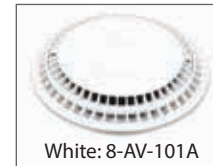

FEATURES

Our 8-inch Anti-Entrapment VGB Drain Covers can be used for single or multiple drains on the pool floor or wall. They are VGB certified for safety and provide exceptional flow rates.



- For Single or Multiple Drain
- Safety Engineered: VGB, ANSI/APSP-16 2011 and NSF/ANSI 50-2015 Compliant
- Gradual slope for comfort and to reduce pool cleaner hang ups
- Flow Rates for 2-inch pipe: Floor 112 GPM, Wall 76 GPM
- Flow Rates for 3-inch pipe: Floor 148 GPM, Wall 100 GPM
- Manufactured from superior UV-Resistant ABS
- Available in 7 designer colors
- Proudly made in the USA
- Includes drain cover, mud ring, and four flat head Phillips screws

10-inch VGB Anti-Vortex Drain Cover

Color Options

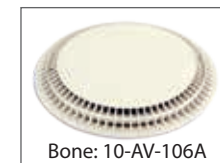

FEATURES

Our 10-inch Anti-Entrapment VGB Drain Covers can be used for single or multiple drains on the pool floor or wall. They are VGB certified for safety and provide exceptional flow rates.



- For Single or Multiple Drain
- Safety Engineered: VGB, ANSI/APSP-16 2011 and NSF/ANSI 50-2015 Compliant
- Gradual slope for comfort and to reduce pool cleaner hang ups
- Flow Rates for 2-inch pipe: Floor 152 GPM, Wall 152 GPM
- Flow Rates for 3-inch pipe: Floor 184 GPM, Wall 144 GPM
- Manufactured from superior UV-Resistant ABS
- Available in 7 designer colors
- Proudly made in the USA
- Includes drain cover, mud ring, and four flat head Phillips screws

8-inch VGB High Flow Drain Cover

Patent Pending

Color Options

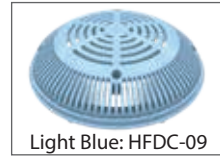

FEATURES

Our 8-inch VGB High Flow Anti-Entrapment Drain Cover is the perfect drain cover for both new construction or remodeling. Great for residential and commercial pools.

- For single or multiple drain
- Safety Engineered: VGB, ANSI/APSP 16-2011 and NSF/ANSI 50-2015 Compliant
- Gradual slope for comfort and to reduce pool cleaner hang ups
- Flow Rates:
 - 2-inch pipe: Floor 160 GPM, Wall 68 GPM
 - 2.5-inch pipe: Floor 195 GPM Wall 76 GPM
- Manufactured from superior UV-Resistant ABS
- Proudly made in the USA
- Includes drain cover, mud ring, and two Phillips screws



8-inch VGB Retrofit Drain Cover

Patent Pending

FEATURES

Our "Retrofit 8" Universal Drain Cover & Adaptor Plate fits any existing sump or plaster ring up to 8-inches in diameter, making it the perfect replacement drain cover for commercial or residential pools.

- For Single or Multiple Drain
- Safety Engineered: VGB, ANSI/APSP-16 2011 and NSF/ANSI 50-2015 Compliant
- Flow Rates: 156 GPM floor, 88 GPM wall
- Gradual slope for comfort and to reduce pool cleaner hang ups
- Manufactured from Superior UV-Resistant ABS materials
- Available in 7 designer colors
- Proudly made in the USA
- Includes drain cover, adaptor plate, and multiple screws

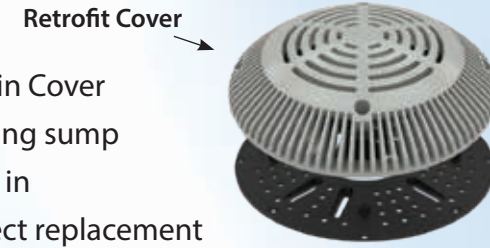

Color Options

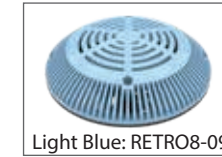

10-inch VGB High Flow Drain Cover

Patent Pending

Color Options



FEATURES

Our 10-inch VGB High Flow Anti-Entrapment Drain Cover has the highest flow rate on the market, making it the perfect drain cover for both new construction or remodeling. Great for residential and commercial pools.

- For single or multiple drain
- Safety Engineered: VGB, ANSI/APSP 16-2011 and NSF/ANSI 50-20015 Compliant
- Gradual slope for comfort and to reduce pool cleaner hang ups
- Flow Rates:
 - 2-inch pipe: Floor 256 GPM, Wall 120 GPM
 - 2.5-inch pipe: Floor 280 GPM Wall GPM 160
 - 3-inch pipe: Floor 281 GPM, Wall 200 GPM
- Wide base ring that fits over most major brand sumps
- Manufactured from superior UV-Resistant ABS
- Proudly made in the USA
- Includes drain cover, mud ring, and four Phillips screws



10-inch VGB Retrofit Drain Cover

Patent Pending

FEATURES

Our 10-inch Anti-Entrapment VGB Drain Covers can be used for single or multiple drains on the pool floor or wall. They are VGB certified for safety and provide exceptional flow rates.

- For Single or Multiple Drain
- Safety Engineered: VGB, ANSI/APSP-16 2011 and NSF/ANSI 50-2015 Compliant
- Gradual slope for comfort and to reduce pool cleaner hang ups
- Flow Rates for 2-inch pipe: Floor 152 GPM, Wall 152 GPM
- Flow Rates for 3-inch pipe: Floor 184 GPM, Wall 144 GPM
- Manufactured from superior UV-Resistant ABS
- Available in 7 designer colors
- Proudly made in the USA
- Includes drain cover and four flat head Phillips screws



Color Options



DESIGNER FITTINGS

SQUARE Flush Mount Return Fitting

Patent Pending

Color Options



FEATURES

Our SQUARE Flush Mount Return Fitting works perfectly with your square tile for an exact fit every time. No more trying to cut or shape tile to match a round fitting. Now your square tile has the perfect square fitting to match.

- This unique patent-pending design allows square tiles to fit perfectly for a seamless look
- Easy installation, no more cutting tile to fit
- Finishes flush with pool wall for a clean look
- Fits inside 1 1/2" pipe or outside 1" pipe
- Built-in water stop to help eliminate leaks
- Manufactured from UV-Resistant ABS
- Available in 8 designer colors
- Proudly made in the USA

Look for two SQUARE Flush Mount Fittings on Left Page 40 picture



Flush Mount Return Fittings

Color Options



FEATURES

- Fits inside 1 1/2-inch pipe or outside 1-inch pipe
- Finishes flush with pool wall
- Three built-in water stops to help eliminate leaks
- Manufactured from UV-Resistant ABS
- Available in 8 designer colors
- Proudly made in the USA
- Sold individually, 50 per bag, or 250 per case



Photo: Alpentile

Australian Return Fitting

Color Options



FEATURES

- Designed for use with 1 1/2" pipe
- Knock-In Fitting - no glue needed
- Special design rotates to help compensate for offset plumbing
- Front flange conceals pipe
- Adjustable eyeball
- Manufactured from UV-Resistant polypropylene material



Threaded Eyeball Fitting

Color Options



FEATURES

- Fits any standard 1 1/2" female pipe thread
- Adjustable eyeball
- Front flange conceals pipe
- Manufactured from UV-Resistant ABS
- Proudly made in the USA



Mushroom Return Fittings

Color Options



FEATURES

- Designed for use with 1" pipe
- Knock-In Fitting - no glue needed
- Special design rotates to help compensate for offset plumbing
- Front flange conceals pipe
- Adjustable eyeball
- Manufactured from UV-Resistant polypropylene material



Threaded Wall Fitting

FEATURES

- Mounts flush with plaster to eliminate ugly flange, making it virtually unseen
- Prevents leaks with built-in water stops
- Received any 1 1/2" male threaded fitting
- Saves money because you no longer need to stock multiple colored fittings
- Versatile uses include pairing with our threaded eyeball fittings, pool vacuum lines, and more
- Manufactured from Superior UV-Resistant PVC



Standard Pole Holder Sets

FEATURES

- Great for Umbrellas, Volleyball Poles and Tiki Torches
- Designed to hold 1 1/2" Pole
- Press in flange, no glue needed
- Flange can be removed for easy replacement
- Can be installed on floor, step or deck
- Built-in Water Stops reduce leaks
- Threaded Cap closes off unit when not in use
- Available in both 5-inch and 7-inch sizes
- Manufactured from UV-Resistant ABS Material
- Choose from 8 designer colors
- Proudly made in the USA
- Includes pole holder base, flange plug, & threaded cap
- Sold individually or 25 per case



Pole Holder Cap & Plug

REPLACEMENT PART

It's easy as 1-2-3 to replace your Flange Plug and Cap on our Pole Holders

1. Simply remove the old cap and plug
2. Press in the new Flange Plug (no glue needed)
3. Screw on the new threaded Cap



Color Options



- See our Pebble Top Pole Holders on Page 27 -

Rope Anchor

FEATURES

- Large Center Rod for Maximum Strength
- Small Outer Body for a Clean Finished Look
- Made of Strong ABS Plastic
- Proudly made in the USA
- Sold individually, 50 per bag, or 250 per case



Color Options



Wall Steps (Set of 3)

FEATURES

- Non-Slip pattern on front of step
- Reinforced with extra strong ribs to prevent breakage
- Full 15" length required by many states
- Manufactured from UV-Resistant ABS Plastic
- Includes 3 steps per set
- Sold as individual set or case of 4 sets



Color Options



Water Stop Pipe Sleeves

FEATURES

The most common place for a pool to leak is along the pipe lines. Prevent that from happening by using our Water Stop Pipe Sleeves. Our Water Stop Pipe Sleeves are glued to the pipes, creating a water barrier that virtually eliminates water leaks and costly repairs.

- Prevents leaks due to expansion and contraction of plaster and/or other finish materials
- Helps prevent costly repairs
- Available in 5 sizes for: 1" Pipe, 1 1/2" Pipe, 2" Pipe, 2 1/2" Pipe, and 3" Pipe
- Manufactured from High Grade PVC
- Proudly made in the USA

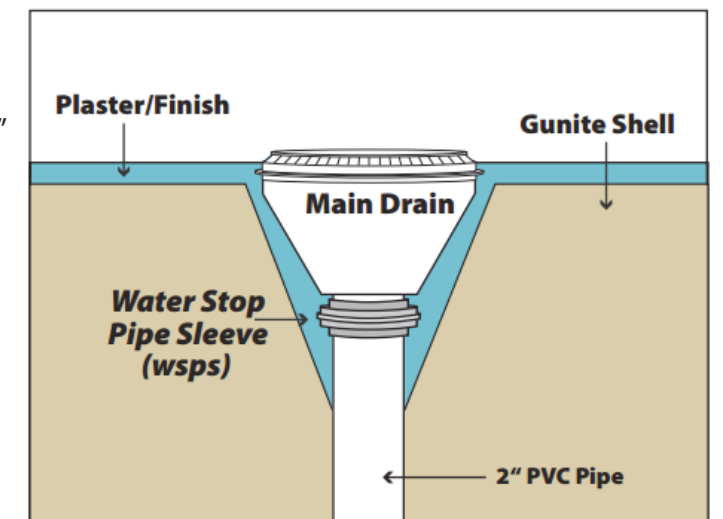

Part Numbers

- | | | |
|----------------|----------------------|----------------|
| 1-inch: WSPS-1 | 1 1/2-inch: WSPS-1.5 | |
| 2-inch: WSPS-2 | 2 1/2-inch: WSPS-2.5 | 3-inch: WSPS-3 |





HOW TO ORDER

... FOUR EASY WAYS

- Online at www.poolfittings.com
- Fax your order to [623-337-4126](tel:623-337-4126)
- Email your order to sales@poolfittings.com
- Call our office at [623-337-4120](tel:623-337-4120)

A WORD FROM OUR CUSTOMERS

"Bakersfield Pool Plastering has been doing business with Color Match since 2005 and we've always been impressed with the quality of their products and turn around time. Color Match has always listened to our needs and we appreciate their superior customer service."

— Andrea, Bakersfield Pool Plastering

"NPT Norcross, GA has an excellent working relationship with Color Match. They have fast shipping on orders and great products and we recommend everyone use them."

— National Pool Tile

"We have been using the Color Match Pebble-Top Drain Covers for a number of years now and my builders love them. It is a great low cost add on that just completes a job. Great product!"

— Kenny, SCP Distributors

MEMBERSHIPS

- Association of Pool & Spa Professionals
- National Plasterers Council
- Carecraft
- United Aqua Group

INNOVATIVE PRODUCTS

For 20 years, Color Match Pool Fittings has led the way in creating innovative pool drain covers & fittings that go beyond ordinary. We look forward to partnering with you to take your pool designs to the next level.

SAFETY ENGINEERED

All of our Drain Covers are safety certified and are VGB, ANSI/APSP-16 2011 and NSF/ANSI 50-2015 compliant. You can download our current Certificate of Listing at www.poolfittings.com.

MADE IN THE USA

We are doing our part to build a stronger America. When you buy from us, you can take great pride in supporting American jobs and in helping our economy. Our products are built with quality you can trust. Buying from an American company means products are in stock and will get to you faster.

FAST SHIPPING

We know that building materials are time-sensitive to your project. That's why we offer same-day shipping on most orders placed by 12 noon MST Monday- Friday. We also offer express shipping options, as needed.

GO BEYOND ORDINARY

Color Match Pool Fittings is a leader in innovative pool products that your customers will love and that will set you apart from your competition. Take your designs to the next level using our disappearing drains and fittings that “Go Beyond Ordinary.”



www.poolfittings.com 623-337-4120 info@poolfittings.com
26204 N. 56th Dr., Phoenix, AZ 85083